



Promise of Perfection



Redefining The Art of Tiles

Since the beginning of Akij Ceramic's journey in 2012, rather than just creating tiles, it has been an effort to implement aesthetic development in lifestyle, a philosophy of pursuing perfection, precisely transformed into the best product that can ever exist. The hard work and dedication has made Akij Ceramics acquire a leading position in the Tiles industry of Bangladesh.

Starting with 20000 square meter tiles production per day, the growing demand in the market has led Akij Ceramics to produce 49500 square meter tiles per day.

State-of-the-art technology combined with the superior brains in the tiles industry have brought beautifully crafted wall and floor tiles to existence. Mirror Polished, Rustic, Satin Matt tiles and many more textures continued to give the consumers the experience of a lifetime. The consumers have been empowered not only with best designs and various sizes, but with impeccable durability that has become the market standard since.

Using the latest European technologies in its facilities, Akij Ceramics is working relentlessly to minimize its carbon footprint. Crafting every day, the experience of a lifetime, Akij Ceramics is developing continuously with an unquenched thirst to remain the best in the tiles industry and to provide you the very best experience of tiles, humanly possible.



The premium range of floor tiles from Kathena is of international standard quality. The magnificent designs are aristocratic and elegant. They give your homes the sophistication that is also associated with your persona and stature.

600X1200mm



Oxford Ivory

600X1200mm



Travertino Royal



12 PGVT 1



12 PGVT 2



12 PGVT 3



12 PGVT 4



12 PGVT 5

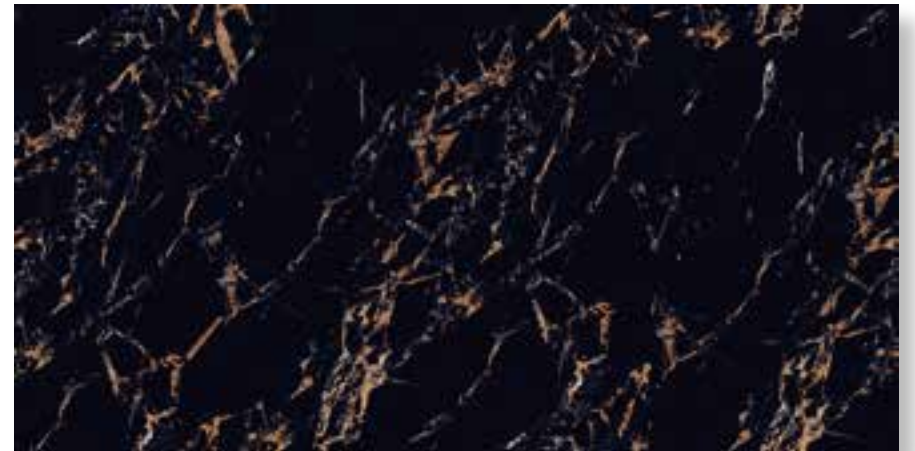

12 PGVT 6



12 PGVT 7



12 PGVT 8



12 PGVT 9

If shine is what matters the most, then the 600x1200mm High Gloss tiles collection is the perfect choice for you. Along with a premium glaze, the natural finish enhances the look of the patterned tiles and your spaces look refined and luxurious. The High Gloss collection is scratch resistant and has a reputation for durability. Being the perfect example of classiness and sophistication, these tiles are natural fit for living rooms, bed rooms, offices, and other similar places.



12 SG AMAZON

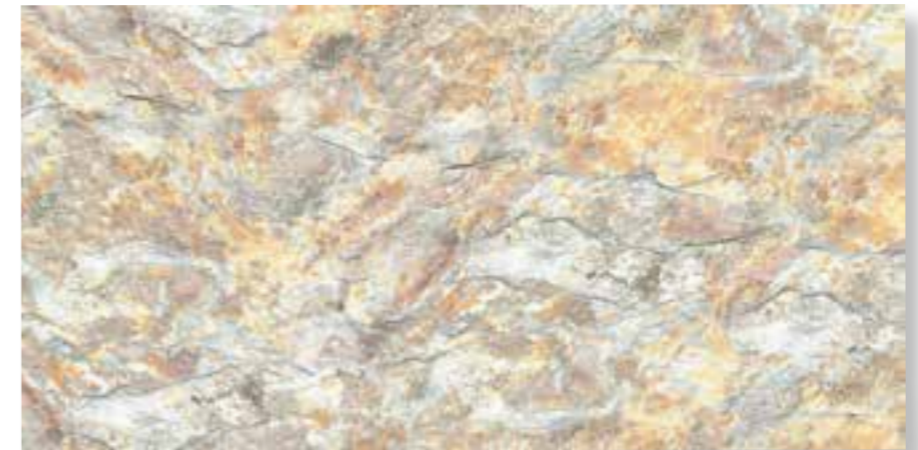

12 SG RED STONE



12 SG RANGOLI

SUGAR

Impeccable finesse and exquisite surface beauty define the Sugar Finish tiles. The unique touch of stability and sense of fashion make the already dynamic sugar finish tiles stand out in the crowd. These Vitrified tiles are more scratch resistant than regular tiles. Adding definition to a space, they change the entire look to your liking. Created with the combination of royal essence and contemporary elegance, the Sugar Finish tiles are best suited for living rooms, bed rooms and lavish offices.

The invention of tiles came with the freedom of choice in decorating homes and commercial spaces. From the first tile in history, this invention has come a long way giving birth to numerous sizes and designs in favor of different usage. With the evolving needs in decorating large spaces, both home and commercial, architects have been feeling the need of aesthetically pleasing durable tiles that can magnify the beauty of any space they design. To bring the perfect solution, Akij Ceramics has introduced 800x800mm large tiles with various texture and design, fulfilling every need of the architects.

The tile is 12mm thick and comes in various designs addressing different needs of different spaces. The range of this premium quality porcelain tiles boasts both matt and glossy engraving design. Among those, Travertine inspired design, Onyx Marble inspired design and Wood Oak design are the most sought after around the world. Beside engraved, polished, and matt textures, these beautiful tiles also come in Lappato finish, a cement face inspired semi-gloss appearance.

For their large scale contemporary projects, as the architects are not just seeking durable tiles, but something magnificently beautiful to eyes and life-like to tactile senses, the 800x800mm tiles from Akij Ceramics come as a natural choice, leaving others leagues behind.

800X800mm



8 PGVT 1

800X800mm



8 PGVT 3

800X800mm



8 PGVT 4

800X800mm



8 PGVT 7

800X800mm



8 PGVT 9

800X800mm



8 PGVT 16



8 PGVT 2



8 PGVT 18



8 PGVT 19



8 PGVT 10



8 PGVT 6



8 PGVT 8



8 PGVT 11



8 PGVT 12

800X800mm



8 PGVT 20



8 PGVT 13



8 PGVT 14

TRAVERTINE INSPIRATION

Travertines bring an indisputable elegance to classic ambiances as well as to the spaces designed with a contemporary look. These tiles reveal the beauty of natural stone with a touch of unique style that few materials created by the hand of man can equal. The spaces where Travertines deploy their tonalities, are recreated into worlds where classic essence goes hand in hand with modernism.



8 PGVT 15



8 PGVT 17



8 PGVT 5

800X800mm



8SM PRESTIGE PECH

800X800mm



8SM PARIS

800X800mm



8SM IMPRESSION

800X800mm

Living Office Hotel

PT SM



8SM 2 BE

800X800mm

Living Office Hotel

PT SM MC



8SM ALMOND PEACH



8SM 1 LG



8SM 1 DG



8SM 3 BE



8SM TRAVERTINE GREY

800X800mm



8SM OSCAR 3

800X800mm



8SM OSCAR 5

800X800mm



8SM WHITE WOOD

800X800mm



8SG PINE WOOD 1

800X800mm



8SM ROSE WOOD

DOUBLE CHARGE

With evolving time, needs in the construction field have evolved as well. As cutting edge technology is taking over, products are now more focused to address problems that previously were ignored. The same thing happened to tiles industry. While the introduction of tiles to the world brought convenience and freedom in decoration for many spaces, tiles in high traffic areas suffered the erosion of surface texture and damage easily due to heavy footfall. To bring an end to this suffering, Akij Ceramics has introduced Double Charge Porcelain Tiles, a perfect solution to take the abuses in high traffic areas.

The top layer of these highly durable mirror polished tiles is 2-3mm thick. Because of this feature, these tiles can withstand much more abuses while retaining their beauty for a longer period of time. As the MoH (Measurement of Hardness) of these tiles is high in number, the longevity of these tiles is very high as well. In a result, these 'natural marble look' tiles can endure extreme abuses in commercial spaces, offices, hotels, shopping malls and indoors yet retain their polished look effortlessly.

There was a time, when for superior construction quality, Bangladesh had no way but to rely on imported construction materials. But the time has changed now because of relentless effort and foresight of pioneers like Akij Ceramics. By introducing Double Charge Porcelain Tiles, Akij Ceramics has paced a step further towards the golden age of construction, creating a class of its own.

600X600mm



6 MATRIX 1

600X600mm



6 MATRIX 2

600X600mm

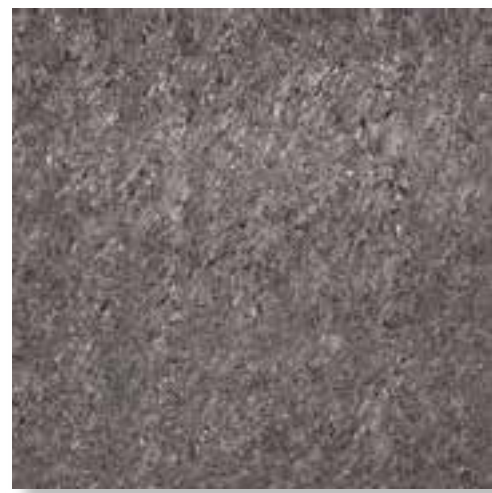

6 MATRIX 3

600X600mm



6 MATRIX 5

600X600mm



6 MATRIX 6

600X600mm



6 MATRIX 7

600X600mm



6 PULATI 1

600X600mm



6 PULATI 2

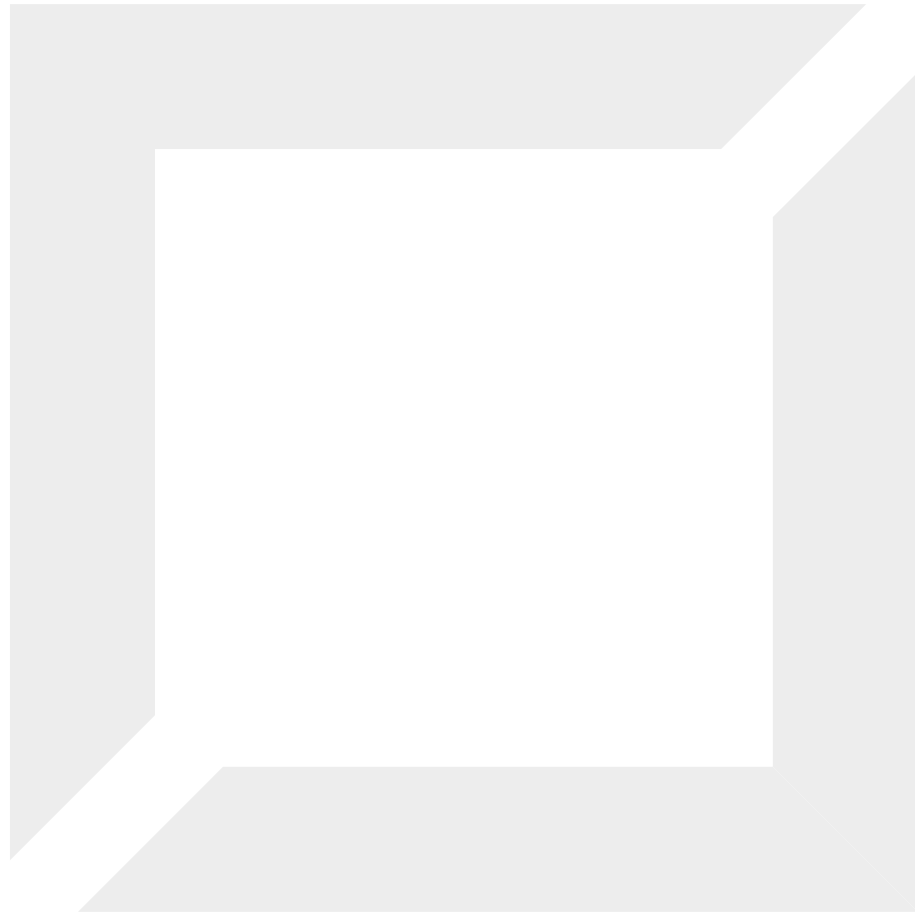

The mass favourite- Glazed Vitrified Tiles and Polished Glazed Vitrified Tiles are the most tested and sought after tiles in the ceramic industry. Neither their core strength nor the surface lustre fade with time. The everlasting beauty of these tiles makes them eligible to suit in any place perfectly. Retaining the elegance and classy look in all conditions, these tiles make a great choice for commercial spaces, restaurants, and houses.

600X600mm

RUSTIC TILES

Normally, Rustic tiles mean the glazed decorative tiles. Among the variations, porcelain body and matt-based glazed are considered mainstream. In Chinese language, 'Rustic' means 'rough', which indicates that the color and the appearance of these antique looking tiles focus on raw elements of nature.



6 RS 1 BR



CEMENT SERIES TILES INSPIRATION

Cement-sand-aggregate, the most banal of building materials is elusive and may not appeal to touch as a well-fired brick, but when the mixture is used in the right combination by brilliant architects, the results are riveting and astonishing. Architects have praised its aesthetic and atmospheric qualities not just for its abilities in form-making, but for the feel of this material, the light and shadow it creates, its particular sense of 'grunt' – or its lightness and delicacy.

The cement series tiles of Akij Ceramics prevail the similar truthfulness of its tactile quality and allure a feeling of the same cementitious character that Architects cherish. The Cement Series Tiles are among the most practical and beautiful types of tiles available and can stand up to a lot of use, making them a great choice even for areas that see a lot of traffic. You don't need to worry about stains or scratches as long as the tiles are properly installed and maintained, as their surfaces are very hardwearing.

Choosing Akij Ceramics Cement Series Tiles can be truly rewarding for a unique tiling solution that can add color, style and a designer feel to every room at your home. A thoughtful application of the tiles of such stature can make asymmetry as graceful as symmetry, or turn volumes of space into engrossing mysteries.



6 RS 1 GR



6 RS 1 GY



6 RS 1 LBE



6 RS 1 DGR



6 RS 1 DGRK

600X600mm

SATIN MATT

Satin Matt tiles are suitable for any space of the house, especially for the vast bathrooms using intricate light design. Because of the soft and sober appearance, often Satin Matt tiles can be considered as the substitute of natural stone. These tiles can be cleaned easily and provide the essence of a bigger space. For this reason, the Satin Matt tiles can also be used in living room, bedroom, dining area and on the ceiling. These tiles are smooth to touch and offer a softer appearance than the other finishes.



6SM 16

600X600mm



6SM 15



6SM 6 GY



6SM 2 BE



6SM 1 BE



6SM 3 BR



6SM 14

600X600mm



6SM 4 BR



The name VANITA is an Italian word, meaning grace and refinement. This refinement and flair in lifestyle is reflected in the exquisite and posh designs of our premium range of kitchen and bathroom wall tiles.



V MT 30616 LBE



VD MT 30616



V MT 6014 W2



V MT 30615 W1



V MT 6015 BE



V MT 30615 W2



V MT 30616 DBE

300X600mm



300X600mm



6005 LBE

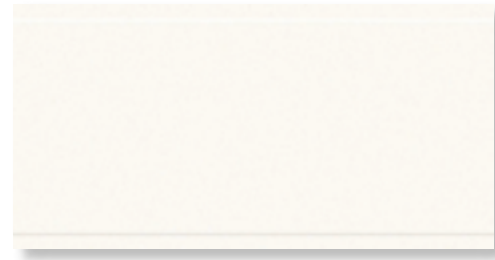

6006 LBE

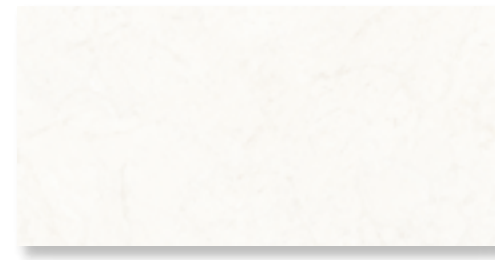

V 3060 9 LBE



V 30603 LGR



6005 DBE

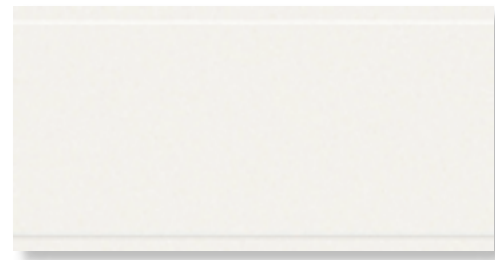

6006 DBE



V 3060 9 DBE



V 30603 DGR

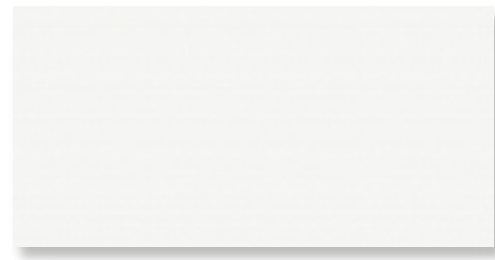

6007 LBR

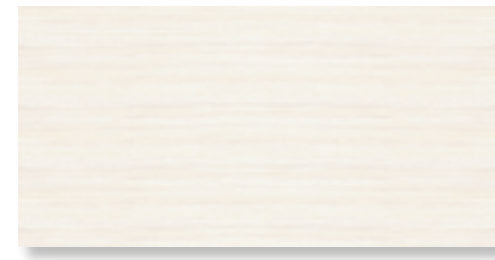

V 3060 7 BE

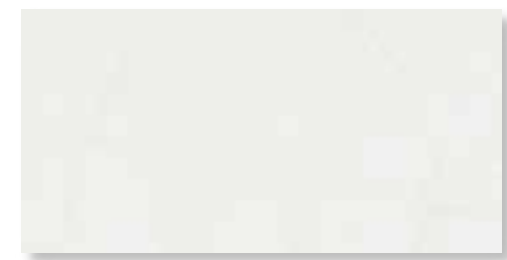

V 30604 LG

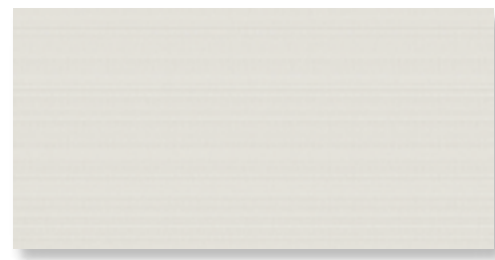

6007 DBR



V 3060 7 DBE

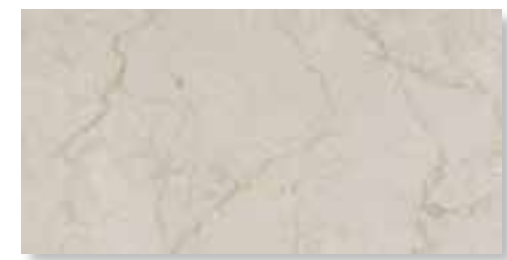

V 30604 DG

300X600mm

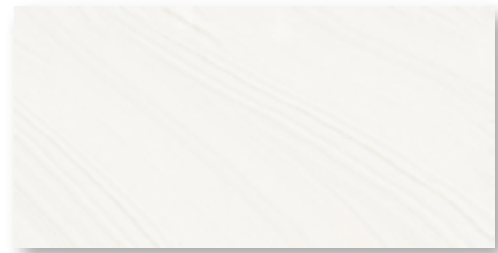

6003 LBE



D 6003 LBE



6003 DBE



300X600mm

 Living

 Light Commercial

 Office

 Hotel

 Indoor

CW

G

RF



V 30618 LBE



V 30618 LG



VD 30618



VD 30618 LG



V 30618 DBE



V 30618 DG

300X500mm



5017 LBR



D 2 5017



5017 DBR



300X500mm

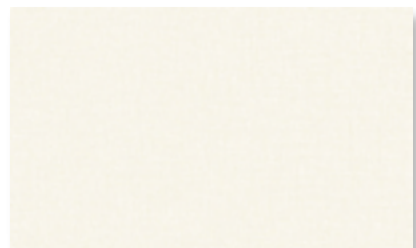

5003 LBE



5015 LG



D 5003 LBE



5015 DBE

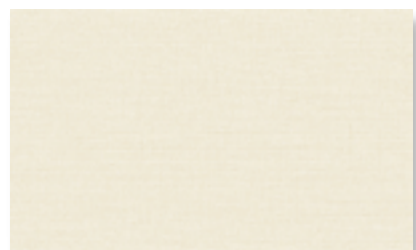

5003 DBE



D 5016



5016 LBE



5016 DBE

300X500mm



RP V30509 LG



RP V30509 GR



RP V30509 BR



RP V30509 BE



RP V30510 BL



RP V30510 BR



RP V30510 GBE



300X500mm

SUGAR

Impeccable finesse and exquisite surface beauty define the Sugar Finish tiles. The unique touch of stability and sense of fashion make the already dynamic Sugar Finish tiles stand out in the crowd. These Vitrified tiles are more scratch resistant than regular tiles. Adding definition to a space, they change the entire look to your liking. Created with the combination of royal essence and contemporary elegance, the Sugar Finish tiles are best suited for living rooms, bed rooms and lavish offices.



V SG 3050 2 LG

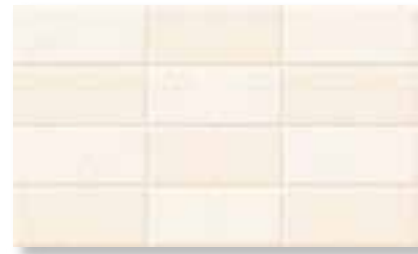

VSG 3050 3 LBE



VD SG 3050 2 IG



VD SG 3050 3



V SG 3050 4 LGR



V SG 3050 2 DG



VSG 3050 3 DBE



V SG 3050 4 DGR



VD SG 3050 4

200X600mm



200X600mm

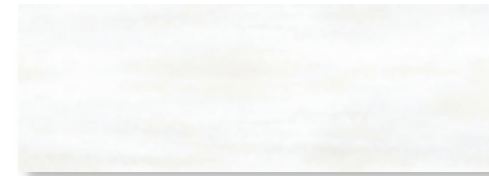

2001 BE

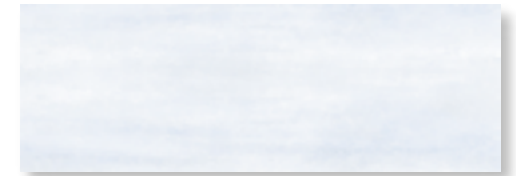

2001 LBL



D 2001 BE



D 2001 BL



2001 DBE



2001 DBL



2005 BE



D 2005



200X600mm

200X600mm

Living

Light Commercial

Office

Hotel

Indoor

CW

M

RF

Hand icon



2006 BE



2006 LGR



2006 LG



2007 LBE



2007 DBE

ROSA

ROSA the designated range of innovative sanitaryware, for the first time in Bangladesh. With the promise of adding a essence of modern lifestyle to you and your family, it has been brought to existence exclusively from Akij Ceramics Ltd.



GRACELIA

Water Closet

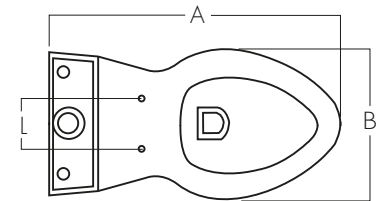
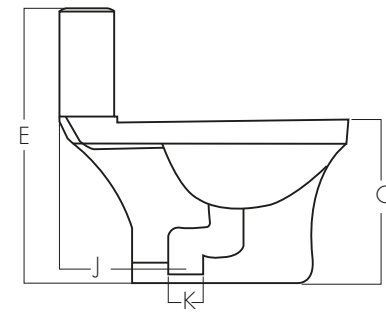

ITEM	A	B	C	E	L	J	K	Wgt. kg
Gracelia 'S' TRAP (Water Closet)	700	360	400	800	150	240	102	26.5

All dimensions are in MM. Tolerance $\pm 5\%$

BONITA

Wall Hung Water Closet

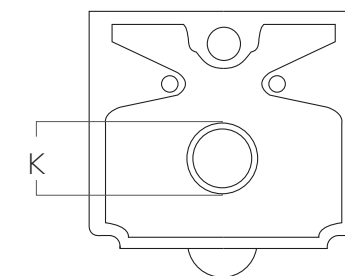
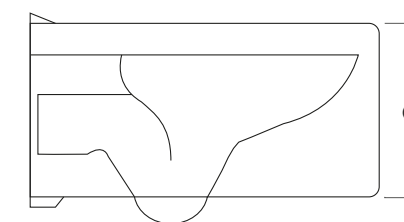
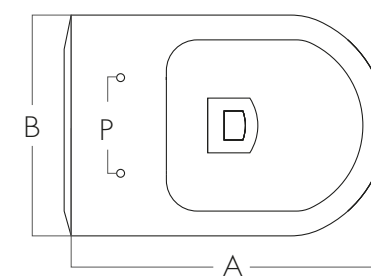

ITEM	A	B	C	K	P	Wgt. kg
Bonita 'P' Trap (Wall Hung)	570	360	305	102	145	28

All dimensions are in MM. Tolerance $\pm 5\%$



FIONA
Water Closet

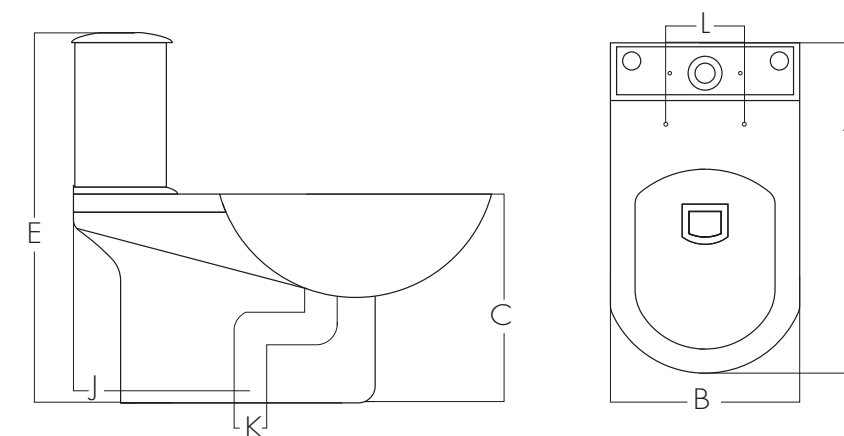

ITEM	A	B	C	E	J	K	L	Wgt. kg
Valentina 'S' TRAP (Water Closet)	690	360	400	780	240	102	145	26.5

All dimensions are in MM. Tolerance $\pm 5\%$

MyHome

Back-to-Wall Toilet

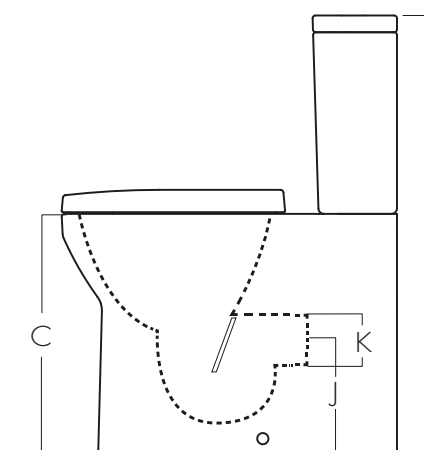
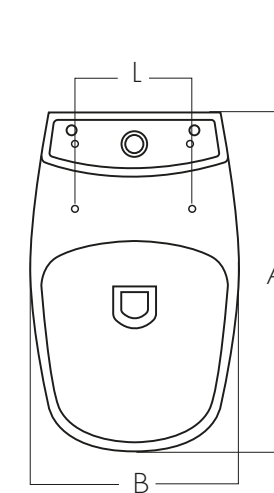

ITEM	A	B	C	E	L	J	K	Wgt. kg
MyHome CC BTW WC. ('P' Trap)	600	365	425	780	155	180	102	29.8

All dimensions are in MM. Tolerance $\pm 5\%$



SHELL BOWL

Table Top

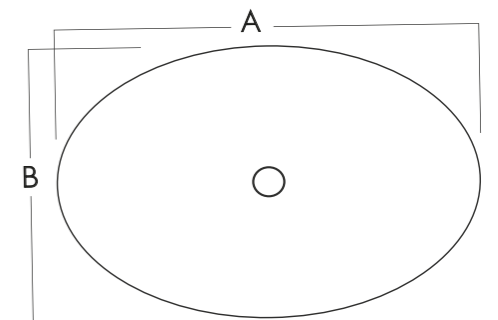
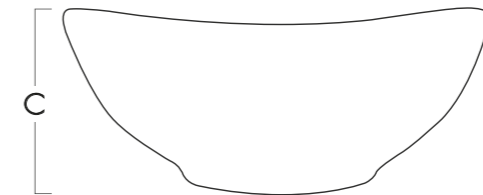

ITEM	A	B	C	Wgt. kg
Shell Bowl (Table Top)	435	345	185	7.5

All dimensions are in MM. Tolerance $\pm 5\%$

DEIGO

Over Counter

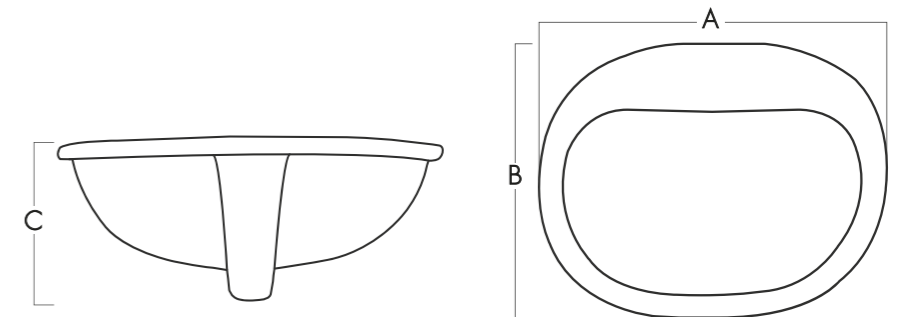

ITEM	A	B	C	Wgt. kg
Deigo (Over Counter)	560	485	210	7

All dimensions are in MM. Tolerance $\pm 5\%$

MYHOME

Semi-counter top Basin

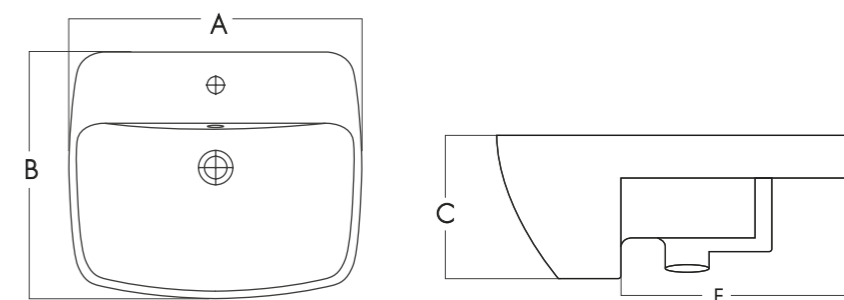

ITEM	A	B	C	E	Wgt. kg
MyHome Semi CTP Basin 50cm	500	420	152	275	11.78

All dimensions are in MM. Tolerance $\pm 5\%$



QUORA

Table top Basin

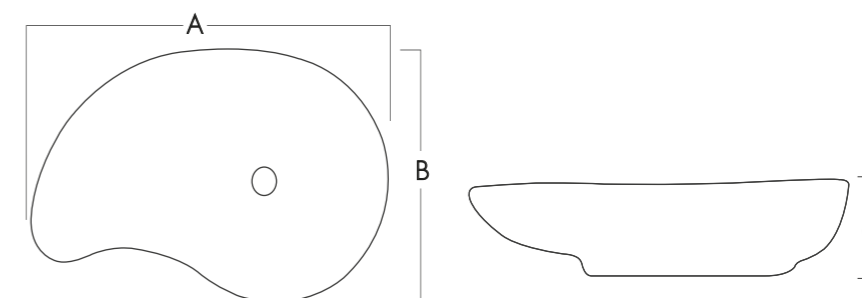

ITEM	A	B	C	Wgt. kg
Quora (Table Top)	660	390	155	10

All dimensions are in MM. Tolerance $\pm 5\%$

Technical Specification

Dry-pressed ceramic tiles with low water absorption Technical Specification

ISO 13006:2012 (E), BDS ISO 13006:2006; Group B la (E≤0.5%)
Work size: 300x300 mm / 400x400 mm / 600x600 mm / 600x1200 mm / 800x800 mm

Date: 2019/10/19

Test Description	Test Method	International Standard	Bangladesh Standard	Akij Ceramics Value
Dimensional & surface quality				
Length & width, deviation in %	ISO 10545-2	±0.6%	±0.5%	±0.1%
Thickness, deviation in % of the average thickness		±5%	±5%	±4%
Straightness of sides, maximum deviation from straightness in %		±0.5%	±0.5%	±0.1%
Rectangularity, maximum deviation in %		±0.5%	±0.5%	±0.2%
Surface flatness, maximum deviation from the surface flatness in % a) centre curvature, related to diagonal, b) edge curvature, related to the work size, c) warpage, related to diagonal,		±0.5%	±0.5%	±0.2%
Surface quality		A minimum of 95% of the tiles shall be free from visible defects.		Minimum of 98% free from visible
Physical properties				
Water absorption, % by weight	ISO 10545-3	≤0.5%	≤0.5%	≤0.2%
Modulus of rupture, in N/mm ²	ISO 10545-4	≥35	≥35	≥40
Resistance to deep abrasion of unglazed tiles: removed in volume, mm ³	ISO 10545-6	Maximum 175	Maximum 175	≤140
Resistance to surface abrasion: of glazed tiles intended for use on floor	ISO 10545-7	Report abrasion class & cycle passed	Report abrasion class & cycle passed	Min. Class II
Coefficient of linear thermal expansion, from ambient temperature to 100°C	ISO 10545-8	Test method available	Test method available	≤6 x 10 ⁻⁶
Thermal shock resistance	ISO 10545-9	Test method	Test method	Resistant
Crazing resistance, for glazed tiles	ISO 10545-11	Required	Required	3 Cycles Passes
Frost resistance	ISO 10545-12	Required	Required	Resistant
Chemical properties				
Resistance to staining a) glazed tiles; b) unglazed tiles;	ISO 10545-14	For glazed tile: Min. Class 3 For unglazed tile: Manufacturer to state classification	For glazed tile: Min. Class 3 For unglazed tile: Manufacturer to state classification	For glazed tile: Min. Class 3 For unglazed tile: Min. Class 2
Resistance to chemicals Resistance to low concentrations of acids and alkalis a) glazed tiles; b) unglazed tiles;	ISO 10545-13	Manufacturer to state classification	Manufacturer to state classification	No damage
Resistance to chemicals Resistance to high concentrations of acids and alkalis a) glazed tiles; b) unglazed tiles;	ISO 10545-13	Test method available	Test method available	No damage
Resistance to household chemicals and swimming pool salts a) glazed tiles; b) unglazed tiles	ISO 10545-	Minimum GB Minimum UB	Minimum GB Minimum UB	Minimum GA Minimum UA

Dry-pressed ceramic tiles Technical Specification

ISO 13006:2012 (E), BDS ISO 13006:2006; Group B III (E>10%)
Work size: 300x500 mm / 300x600 mm / 200X600mm

Date: 2019/10/19

Test Description	Test Method	International Standard ISO 13006:2012 (E)	Bangladesh Standard BDS ISO 13006:2006	Akij Ceramics Value
Dimensional & surface quality				
Length & width, deviation in %	ISO 10545-2	±0.75%	+0.6% to -0.3%	±0.3%
Thickness, deviation in % of the average thickness		±10%	±10%	±5%
Straightness of sides, maximum deviation from straightness in %		±0.3%	±0.3%	±0.3%
Rectangularity, maximum deviation in %		±0.5%	±0.3%	±0.3%
Surface flatness, maximum deviation from the surface flatness in % a) centre curvature, related to diagonal, b) edge curvature, related to the work size, c) warpage, related to diagonal,		+0.5% to -0.3%	+0.5% to -0.3%	+0.5% to -0.3%
Surface quality		A minimum of 95% of the tiles shall be free from visible defects.		Minimum of 98% free from visible defects
Physical properties				
Water absorption, % by weight	ISO 10545-3	Average >10%, Individual minimum 9%	Average >10%, Individual minimum 9%	10% to 15%
Modulus of rupture, in N/mm ²	ISO 10545-4	≥15	≥15	≥16
Thermal shock resistance	ISO 10545-9	Test method available	Test method available	Resistant
Crazing resistance, for glazed tiles	ISO 10545-11	Required	Required	Resistant
Frost resistance	ISO 10545-12	Required	Required	Resistant
Chemical properties				
Resistance to staining a) glazed tiles; b) unglazed tiles;	ISO 10545-14	For glazed tile: Min. Class 3 For unglazed tile: Manufacturer to state classification	For glazed tile: Min. Class 3 For unglazed tile: Manufacturer to state classification	For glazed tile: Min. Class 4 For unglazed tile: Min. Class 4
Resistance to chemicals Resistance to low concentrations of acids and alkalis a) glazed tiles; b) unglazed tiles;	ISO 10545-13	Test method available	Test method available	No damage
Resistance to chemicals Resistance to high concentrations of acids and alkalis a) glazed tiles; b) unglazed tiles;	ISO 10545-13	Test method available	Test method available	No damage
Resistance to household chemicals and swimming pool salts a) glazed tiles; b) unglazed tiles	ISO 10545-	Minimum GB Minimum UB	Minimum GB Minimum UB	Minimum GA Minimum UA

SANITARYWARE (Technical Specification)

Conformity to Norms	ROSA Standard
Water Absorption	0.01 - 0.1%
Modulus of Rupture	600 - 650Kg/cm ²
Chemical Resistance	Resist
Crazing Resistance	Resist
Staining Resistance	Resist
Burning Resistance	Resist

ICONS



TYPOLOGY

- PT** Porcelain Tiles
- CW** White Body Ceramics Tiles







SURFACE FEEL

- HG** High Glossy
- MG** Metallic with Glossy
- R** Rustic
- MC** Matt Carving
- G** Glossy
- S** Sugar
- GC** Glossy Carving
- SM** Satin Matt
- RF** Relief/punch
- NT** Nano Technology
- HD** High Durable
- L** Lappato

INDICATION FOR USE

-  Wall
-  Floor

SUGGESTED APPLICATIONS

-  Light Commercial
-  Commercial
-  Living
-  Office
-  Hotel
-  Indoor
-  Outdoor

Product colors in this Brochure are as close to the actual product colors as possible through modern printing process. However, different light conditions and other technical aspects can cause variation in color or shapes. Please refer to actual product for colors.

Corporate Office

Akij House, 198 Bir Uttam Mir Shawkat Sarak
(Gulshan Link Road), Tejgaon, Dhaka-1208, Bangladesh
For More: +880 1755621492-3

Exclusive Experience Centre

Dhaka

Mozaffar Tower, 55 Bir Uttam C.R. Dutta Road
(Old 41 Paribagh, Sonargaon Road), Banglamotor,
Dhaka-1000, Bangladesh
Cell: +88 01777717583

3rd floor, **Navana Zohura Square**
22 Mymensingh Road, Banglamotor,
Ramna, Dhaka. Mobile: +88 01713998704

Sylhet

1 Shahjalal Uposhohor, Block D
Mobile: +88 01777717586

Factory

Mukhopur, Trishal, Mymensingh, Bangladesh

