

AKIJI
CERAMICS

Promise of Perfection



In 2019, Akij Ceramics won the prestigious Best Brand Award in Ceramic Tiles Category from Bangladesh Brand Forum in association with Nielsen Bangladesh. This success only inspires Akij Ceramics to continue making the best quality products, humanly possible.

Redefining The Art of Tiles

Since the beginning of Akij Ceramics' journey in 2012, rather than just creating tiles, it has been an effort to implement aesthetic development in lifestyle and a philosophy of pursuing perfection. Hard work and dedication has enabled Akij Ceramics to acquire a leading position in the Tiles industry of Bangladesh.

Starting with a production capacity of 20,000 square meter tiles per day, the growing demand of the market has led Akij Ceramics to produce 49,500 square meter tiles per day.

State-of-the-art technology combined with the superior brains in the tiles industry have brought beautifully crafted wall and floor tiles to existence. Mirror Polished, Rustic, Satin Matt tiles and many more textures continued to give the consumers the experience of a lifetime. The consumers have been empowered not only with the best designs and various sizes, but also with impeccable durability that has become the market standard since.

Using the latest European technologies in its facilities, Akij Ceramics is working relentlessly to minimize its carbon footprint. Crafting the experience of a lifetime every day, Akij Ceramics is developing continuously with an unquenched thirst to remain the best in the tiles industry and to provide you with the very best.

WALL TILES



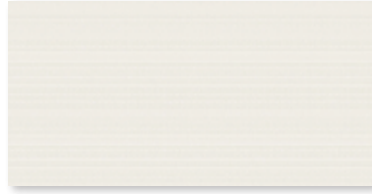

6018 LBR
D 6018 2
D 6018 1
6018 DBR

6007 LBR
D 6007 LBR 3
D 6007 LBR 2
6007 DBR





D 6016 LG 1
D 6016 LG 2



D 6016 LG 3
D 6016 LG 4

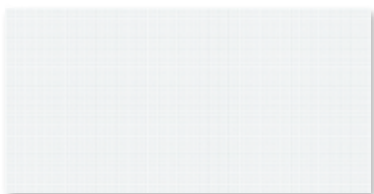

6016 LG



D 6017 1
D 6017 2
6017 LP



D 6015 1
D 6015 2
6015 BE



6012 LG
D 6012 LG

6005 LBE
D 6005 LBE 2
6005 DBE



The name VANITA is an Italian word, meaning grace and refinement. This premium range of kitchen and bathroom wall tiles reflects refinement and flair of our customers' lifestyle in its exquisite and elegant designs.



V 30611 LBE
VD 30611 LBE 2
V 30611 DBE



V 3060 7 BE
VD 30607 BE 3
VD 30607 BE 2
V 3060 7 DBE



V 3060 9 LBE
VD 30609 LBE 2
V 3060 9 DBE



V 30618 LBE
VD 30618
V 30618 DBE

V 3060 5 LBE 2
VD-30605 LBE2
V 3060 5 DBE 2



V MT 30615 W1
V MT 30615 W2



V MT 30616 LBE
VD MT 30616
V MT 30616 DBE



V MT 6014 W2
V MT 6015 BE



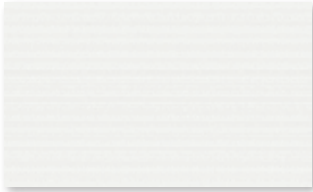
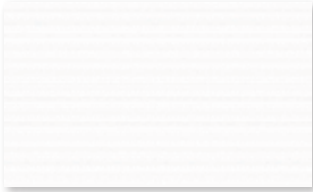

5002 LBE
D 5002 LBE
5002 DBE



5015 LG
D 5015
5015 DBE





5000



5001 BE



5018 LBE
D 2 5018
5018 DBE



5017 LBR
D 5017
5017 DBR





V 30513 LBR
VD 30513 1
VD 30513 2
V 30513 DBR



V 30515 LGR
VD 30615
V 30515 DGR



V 30504 G
VD 30504 G1
V 30504 LM





VSG 30506 LBR
VDSG 30506
VSG 30506 DBR



V SG 3050 4 LGR
VD SG-3050 4
V SG 3050 4 DGR



SUGAR

Impeccable finesse and exquisite surface beauty define the Sugar Finish tiles. The unique touch of stability and sense of fashion make the already dynamic sugar finish tiles stand out in the crowd. These Vitrified tiles are more scratch resistant than regular tiles. Adding definition to a space, they change its entire look to your liking. Created with the combination of royal essence and contemporary elegance, the Sugar Finish tiles are best suited for living rooms, bedrooms and lavish office spaces.



V SG 30501 BE
VD SG 30501 BE 1



V SG 30501 YE
VD SG 30501 YE 1

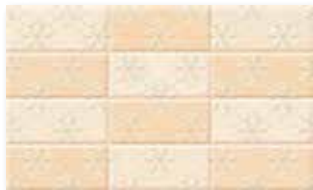
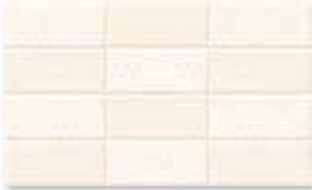

VSG 3050 3 LBE
VD SG 3050 3
VSG 3050 3 DBE



V SG 30501 LBR
VD SG 30501 LBR 1
V SG 30501 DBR



V SG 3050 4 BE
VD 1 SG 3050 4
VD 2 SG 3050 4



V SG 30502 LP
VD SG 30502 LP 1
V SG 30502 DP

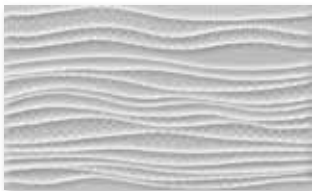

V SG 30502 LG
VD SG 30502 LG 1
V SG 30502 DG



V SG 30502 LBR
VD SG 30502 LBR 1
V SG 30502 DBR



RP V30509 BR
 RP V30509 GR
 RP V30509 BE
 RP V30509 LG



V 30508 R3

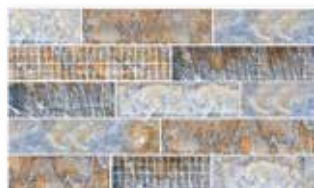

RP V30510 GBE
 RP V30510 BR
 RP V30510 BL



V 30507 R3
 V 30507 R6



2014 LGR
D 2014 1
2014 DGR



2013 LBE
D 2013 1
2013 DBE



2012 LGR
D 2012 1
2012 DGR



2011 LBR
D 2011 1
2011 DBR





N 2003 LBE
N D 2003
N 2003 DBE

2002 LBL
D 2002
2003 DBL

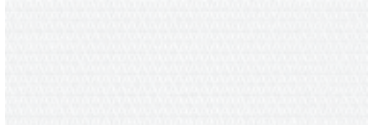

N 2004 LG
N D 2004
N 2004 DG



N 2005 BE
N D 2005

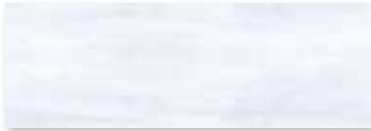

N 2001 BL
N D 2001 BL
N 2001 DBL



N 2001 BE
N D 2001 BE
N 2001 DBE





N 2006 LGR



N 2006 LG



N 2006 BE





1001



1019 L



1083 BL



1083 BE

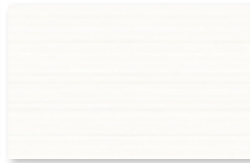

1099 G
D 1099 1
D 1099 2



1098 LBR
D 1098 1
1098 DBR



1034 LBE
D 1034
1034 DBE



1033 LG
D 1033



1032 LGR
D 1032

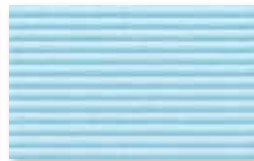
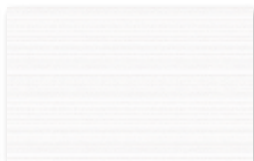

1035 LBL
D 1035 1
D 1035 2
1035 DBL

1097 LBR
D 1097 LBR 1
D 1097 LBR 2
1097 DBR

RP 1003 LBL
RP D 1003
RP 1003 DBL

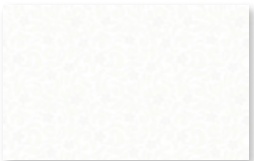

RP 1004 LBE
RP D 1004
RP 1004 DBE

1050 LBE
D 1050 LBE 1
1050 DBE

1084 LBE
D 1084 LBE 1
1084 DBE



1092 LBE
D 1092 LBE 1
1092 DBE

1090 LBE
D 1090 LBE
1090 DBE

1090 LBL
D 1090 LBL
1090 DBL





RP 602 LGR
RP D 602 DGR
RP 602 DGR

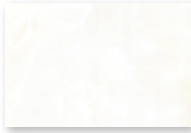

RP 602 LBE
RP D 602 DBE
RP 602 DBE

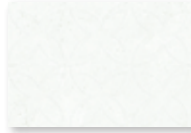

RP 603 LBL
RP D 603 DBL
RP 603 DBL



RP 603 LBR
RP D 603 LBR
RP 603 DBR



RP 601 LBL
RP D 601 LBL
RP 601 DBL

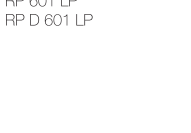

RP 601 LP
RP D 601 LP



RP 601 LBE
RP D 601 DBE
RP 601 DBE



RP 601 LG
RP D1 601 LG
RP 601 DG



RP 601 BR



RP 601 BE



737 BL
D 737

745 LBE
D 745
745 DBE

740 LBR
D 740
740 DBR

736 LBE
D 736
736 DBE



741 BE

746 GR



717 G

747 G

742 G

723 BE

723 BL



686 GPR

686 PBL

724 P

724 BL

707 PGV

707 PBL

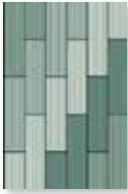

687 GR

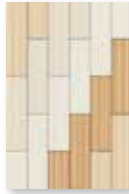

687 YE



688 BL



688 LYE



688 YE



688 GY



690 RS



691 PK



699 PBE



700 PBL



739 BR



701 PBL



705 YE



710 PBL



711 BR



713 Y



720 P



727 G



728 GR



732 GR



734P





607 BE



607 L



608 L



611 GY



619 DBL

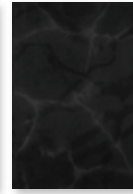

619 BK



619 BR



619 DGR

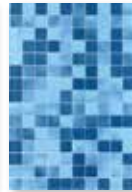

662 BL



643 BL



643 GR



647 BL



661 L

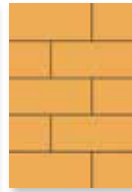

BRK 748 BE

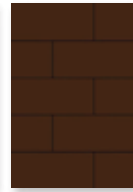

BRK 748 BR

20x7.5 cm | CLADDING TILES



C 01 YE



C 01 C

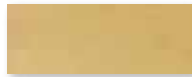

C 01 BE



C 01 OR



C 01 DBE



C 01 BR

FLOOR TILES





OLIVIA WHITE



OXFORD IVORY



TRAVERTINO ROYAL



12 PGVT 1



12 PGVT 3



12 PGVT 2



12 PGVT 9



12 PGVT 7



12 PGVT 5



12 PGVT 8



12 PGVT 4

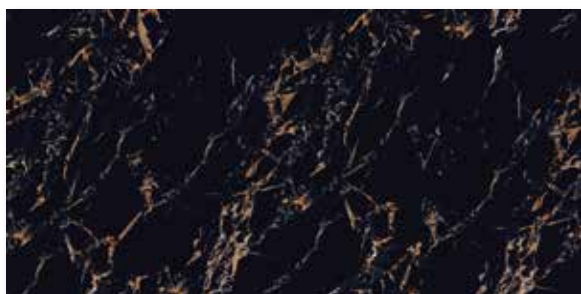

12 PGVT 6



12 SM IMPRESSION



12 SG AMAZON

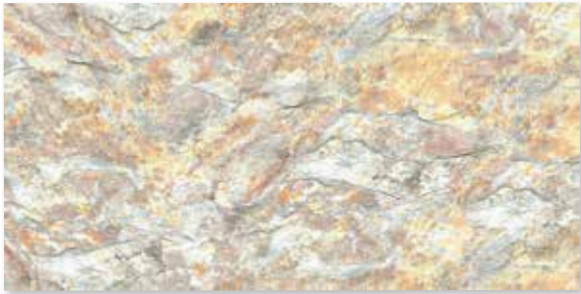

12 SG RED STONE



12 SG RANGOLI



ZAINAMAJ 1

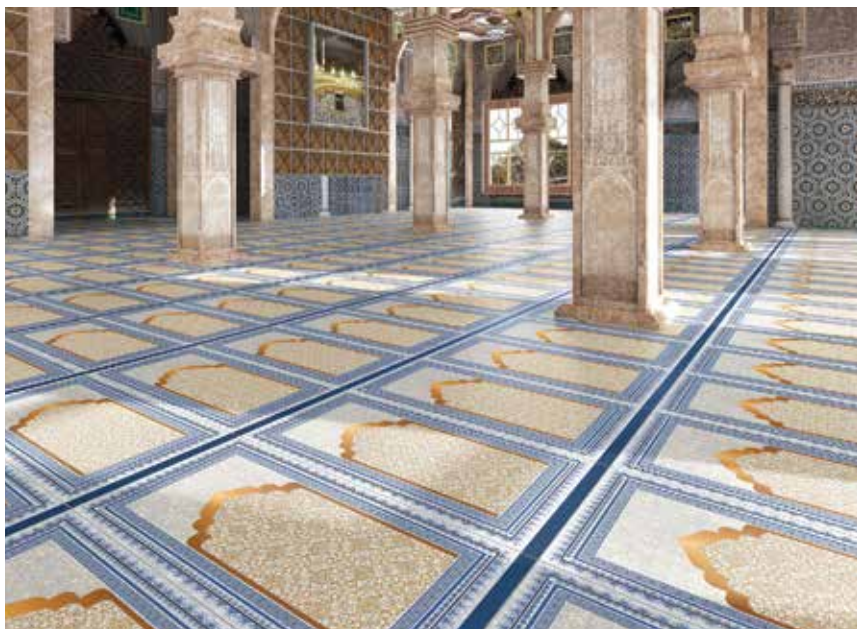



8 PGVT 1



8 PGVT 2



8 PGVT 6



8 PGVT 8



8 PGVT 9



8PGVT 18



8 PGVT 7



8 PGVT 3



8 PGVT 19



8 PGVT 4



8 PGVT 20



8 PGVT 16

The invention of tiles came with the freedom of choice in decorating homes and commercial spaces. From the first tile in history, this invention has come a long way giving birth to numerous sizes and designs in favor of different usage. With the evolving needs in decorating large spaces, both home and commercial, architects have been feeling the need of aesthetically pleasing durable tiles that can magnify the beauty of any space they design. To bring the perfect solution, Akij Ceramics has introduced 800x800 mm large tiles with various texture and design, fulfilling every need of the architects.

KATHENA tiles are 12 mm thick and come in various designs addressing different needs of different spaces. This range of premium quality porcelain tiles boasts both matt and glossy engraved design. Among those, Travertine inspired design, Onyx Marble inspired design and Wood Oak design are the most sought after around the world. Beside engraved, polished, and matt textures, these beautiful tiles also come in Lappato finish, a cement face inspired semi-gloss appearance.

For large scale contemporary projects, architects are not just seeking durable tiles, but something magnificently beautiful to eyes and life-like to tactile senses. Here, the 800x800 mm tiles from Akij Ceramics come as a natural choice, leaving others leagues behind.



8 PGVT 10



8 PGVT 11



8 PGVT 12

TRAVERTINE INSPIRATION

Travertines bring an indisputable elegance to classic ambiances as well as to the spaces designed with a contemporary look. These tiles reveal the beauty of natural stone in such a unique style that few materials created by the hand of man can equal. The spaces where Travertines deploy their tonalities, create worlds where classic essence goes hand in hand with modernism.



8 PGVT 5



8 PGVT 13



8 PGVT 14



8 PGVT 15



8 PGVT 17



8SM ALMOND PEACH



8SM IMPRESSION 8



8SM PARIS



8SM PRESTIGE PECH



8SM 2 BE



8SM 3 BE



8SM 1 LG



8SM 1 DG



8SM OSCAR 3



8SM OSCAR 5



8 SG PINE WOOD 1



8 SM ROSE WOOD



8 SM WHITE WOOD





6 MATRIX 1



6 MATRIX 2



6 MATRIX 3

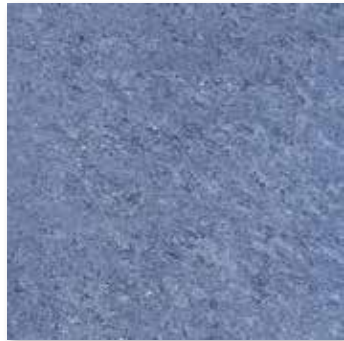

6 MATRIX 5



6 MATRIX 6



6 MATRIX 7



6 PULATI 1



6 PULATI 3

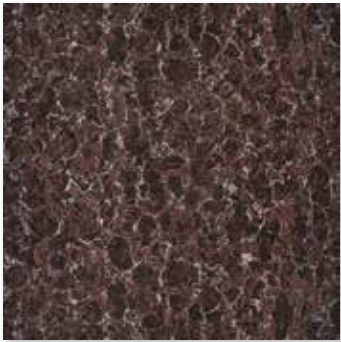

6 PULATI 2

With evolving time, needs in the construction field have evolved as well. As cutting edge technology is taking over, products are now more focused to address problems that previously were ignored. The same thing happened to tiles industry. While the introduction of tiles to the world brought convenience and freedom in decoration for many spaces, tiles in high traffic areas suffered the erosion of surface texture and damage easily due to heavy footfall. To bring an end to this suffering, Akij Ceramics has introduced Double Charge Porcelain Tiles, a perfect solution to take the abuses in high traffic areas.

The top layer of these highly durable mirror polished tiles is 2-3 mm thick. Because of this feature, these tiles can withstand much more abuses while retaining their beauty for a longer period of time. As the MoH (Measurement of Hardness) of these tiles is high in number, the longevity of these tiles is very high as well. As a result, these 'natural marble look' tiles can endure extreme abuses in commercial spaces, offices, hotels, shopping malls and indoors yet retain their polished look effortlessly.

There was a time, when Bangladesh had no other options but to rely on imported construction materials for superior quality. But the time has changed now because of relentless effort and foresight of pioneers like Akij Ceramics. By introducing Double Charge Porcelain Tiles, Akij Ceramics has paced a step further towards the golden age of construction, creating a class of its own.

The mass favourite- Glazed Vitrified Tiles and Polished Glazed Vitrified Tiles are the most tested and sought after tiles in the ceramics industry. Neither their core strength nor their surface lustre fade with time. The everlasting beauty of these tiles makes them eligible to suit in any place perfectly. Retaining the elegance and classy look in all conditions, these tiles make a great choice for commercial spaces, restaurants, and houses.



6 PGVT CG 44



6 PGVT CG 43





6 PGVT CG 38 (RANDOM)



6 PGVT CG 39 (RANDOM)



6 PGVT CG 42



6 PGVT CG 41



6 PGVT CG 40



6 PGVT CG 37



6 PGVT CG 36



6 PGVT CG 34



6 PGVT CG 33



6 PGVT CG 32

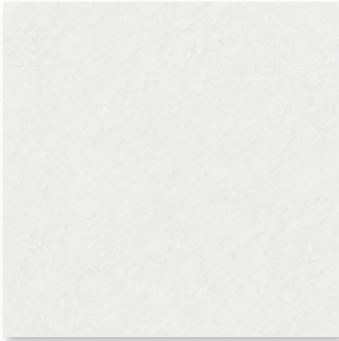

6 PGVT CG 26



6 PGVT CG 25



CG 22



6 PGVT CG15



6 PGVT 16GY



6 PGVT 16BE

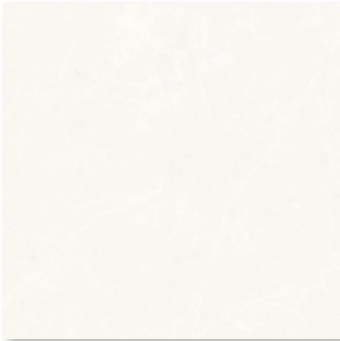

6 PGVT CG09



6 PGVT 1 BE



6 PGVT CG07



6 PGVT 03 BE



6PGVT 17BR1
6PGVT 17BR2



6PGVT 17G1
6PGVT 17G2



6SM 15



6SM 06 GY



6SM 02 BE



6SM 01 BE

SATIN MATT

Satin Matt tiles are suitable for any space of the house, especially for vast bathrooms using intricate light design. Because of the soft and sober appearance, Satin Matt tiles can be considered as the substitute of natural stone. These tiles can be cleaned easily and provide the essence of a bigger space. For this reason, the Satin Matt tiles can also be used in living rooms, bedrooms, dining areas and on the ceiling. These tiles are smooth to touch and offer a softer appearance than the other finishes.



6SM 03 BR



6SM 14



6SM 04 BR



6SM 16



CEMENT SERIES TILES INSPIRATION

Cement sand aggregate, the most banal of building materials is elusive and may not appeal to touch as a well fired brick, but when the mixture is used in the right combination by brilliant architects, the results are riveting and astonishing. Architects have praised its aesthetic and atmospheric qualities not just for its abilities in form making, but for the feel of this material, the light and shadow it creates, its particular sense of 'grunt' – or its lightness and delicacy.

The cement series tiles of Akij Ceramics prevail the similar truthfulness of its tactile quality and allure a feeling of the same cementitious character that architects cherish. The Cement Series Tiles are among the most practical and beautiful types of tiles available and can stand up to a lot of use, making them a great choice even for areas which see a lot of traffic. You don't need to worry about stains or scratches as long as the tiles are properly installed and maintained, as their surfaces are very hardwearing.

Choosing Akij Ceramics Cement Series Tiles can be truly rewarding for a unique tiling solution that can add color, style and a designer feel to every room at your home. A thoughtful application of the tiles of such stature can make asymmetry as graceful as symmetry, or turn volumes of space into engrossing mysteries.





6 RS 01 BR



6 RS 01 GY



6 RS 01 LBE



6 RS 01 GR



6 RS 01 DGR



6 RS 01 DGRK



6 HPV T - 101

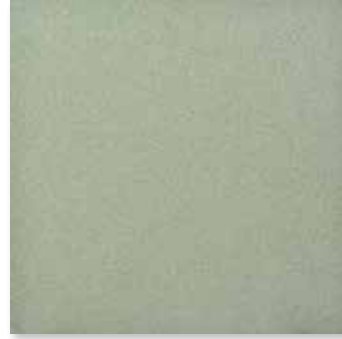

6 HPV T - 104



6 HPV T - 102



6 HPV T - 105



6 HPV T - 103



6 HPV T - 107

6H = 60x60 cm

4H = 40x40 cm

3H = 30x30 cm

6H-101
4H-101
3H-101



6H-102
4H-102
3H-102



6H-103
4H-103
3H-103



6H-105
4H-105
3H-105



6H-104
4H-104
3H-104

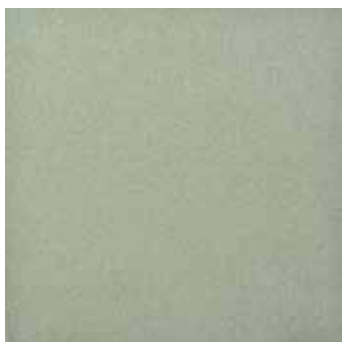

6H-107
4H-107
3H-107



6H-106
4H-106
3H-106





4HP 63



4HP 64



4HP 65



4HP 69



4HP 70 BE



4HP 71



4HP 2002 DBL



4HP 30618 DBE



4HP 30618 LBE



4 HP 56 BL



4HP 72 BE



4HP 62 BE



4HD 57 BL



3HP 30513 DBR



3HP 30506 DBR



2011 LBR



2014 DGR



3HP 2003 DBE



3HP 5016 LBE



3HP 5015 LG

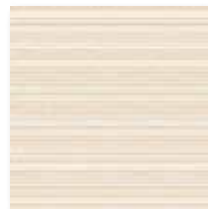

3HP 1097DBR



3HP 30515 LGR



3HP 5018 LBE



3HP 2001 DBE

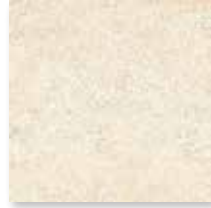

3HP 2005 BE



3HP 1019 L

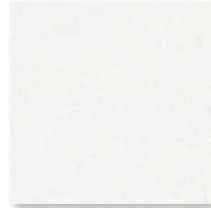

3HP 1035 LBL



3HP 83 BL



3HP RP 1004 LBE

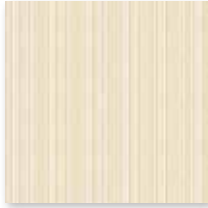

3 HP 1097 DBR



3 HP 30504 DGR



3 HP 71 BE

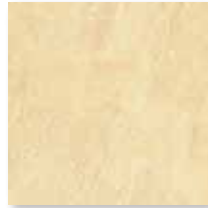

3 HP 90 DBE

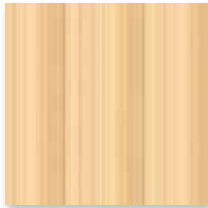

3 HP 1084 DBE



3HP 6007 DBR

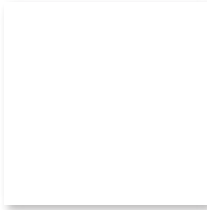

301



311 GY

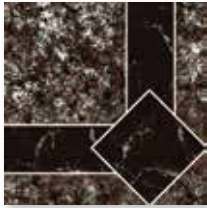

314 BR



317 GR



319 R



320 BE



324 G



334 GP

Load Bearing Capacity Over 6000 N | 15 mm thickness
Skid resistant | Thermal shock & Chemical resistant

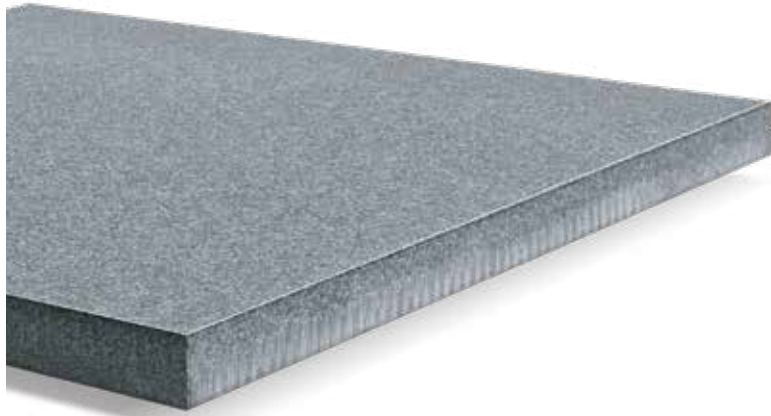

3H 101 HT 15



3H 102 HT 15



3H 107 HT 15

ROSA

INNOVATIVE SANITARYWARE SOLUTION



Gracelia 'S' Trap Water Closet

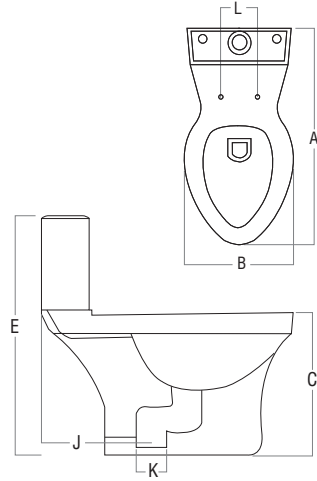

A	B	C	E	L	J	K	Wgt. (kg)
700	360	400	800	150	240	102	26.5

All dimensions are in mm. Tolerance $\pm 5\%$

Gracelia Wash Basin

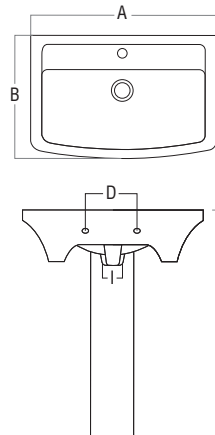

A	B	C	D	I	Wgt. (kg)
500	410	815	135	45	12

All dimensions are in mm. Tolerance $\pm 5\%$

Color range



Valentina 'S' Trap Water Closet

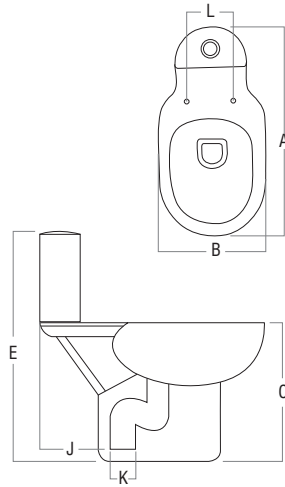

A	B	C	E	L	J	K	Wgt. (kg)
680	360	400	800	150	240	102	20.5

All dimensions are in mm. Tolerance $\pm 5\%$

Valentina Wash Basin

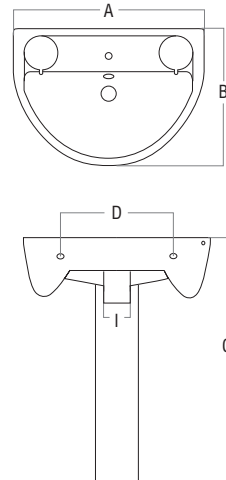

A	B	C	D	I	Wgt. (kg)
600	480	850	280	45	14

All dimensions are in mm. Tolerance $\pm 5\%$

Color range



Marina 'S' Trap Water Closet

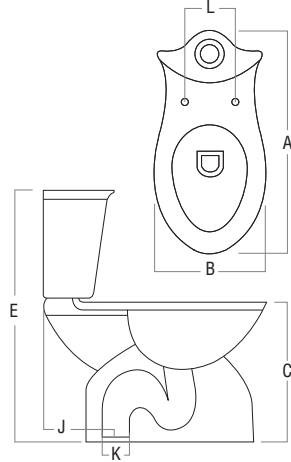

A	B	C	E	L	J	K	Wgt. (kg)
680	360	400	800	150	240	102	20.5

All dimensions are in mm. Tolerance ± 5%

Marina Wash Basin 50 & 60 cm

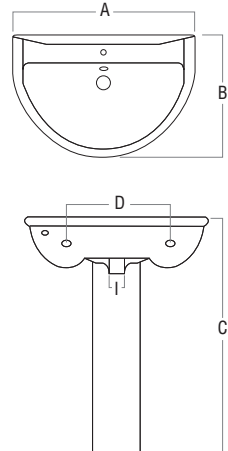

A	B	C	D	I	Wgt. (kg)
500	420	840	230	45	10
600	490	860	280	45	14

All dimensions are in mm. Tolerance ± 5%

Color range



Margo 'S' Trap Water Closet

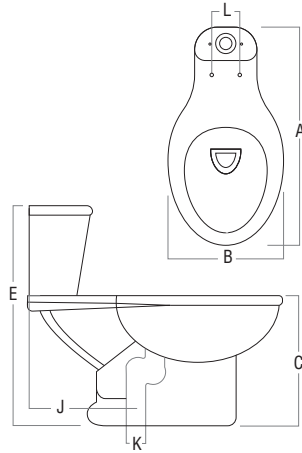

A	B	C	E	L	J	K	Wgt. (kg)
680	360	400	780	150	240	102	19.5

All dimensions are in mm. Tolerance ± 5%

Margo Wash Basin 50 & 55 cm

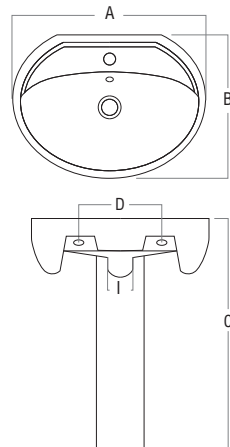

A	B	C	D	I	Wgt. (kg)
500	400	750	145	45	10
550	410	850	145	45	11.5

All dimensions are in mm. Tolerance ± 5%

Color range



Fiona 'S' Trap Water Closet

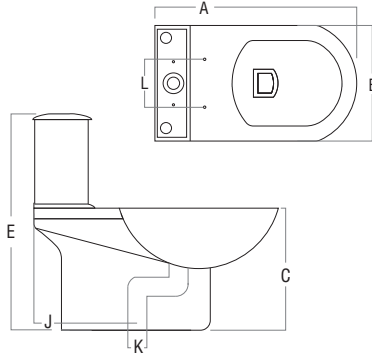

A	B	C	E	L	J	K	Wgt. (kg)
690	360	400	800	145	240	102	26.5

All dimensions are in mm. Tolerance $\pm 5\%$

Thames CC TW Water Closet ('P' Trap)

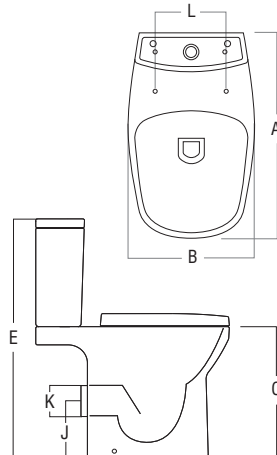

A	B	C	E	L	J	K	Wgt. (kg)
600	365	425	780	155	180	102	23.06

All dimensions are in mm. Tolerance $\pm 5\%$

Thames CC BTW Water Closet 'P' Trap

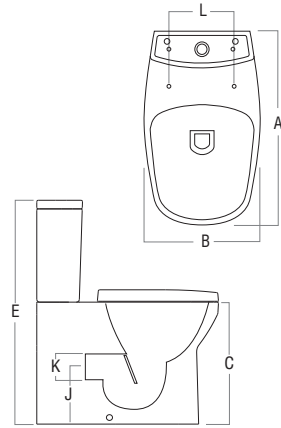

A	B	C	E	L	J	K	Wgt. (kg)
600	365	425	780	155	180	102	29.8

All dimensions are in mm. Tolerance ± 5%

Thames Wash Basin 40 cm, 50 cm, 55 cm & 60 cm

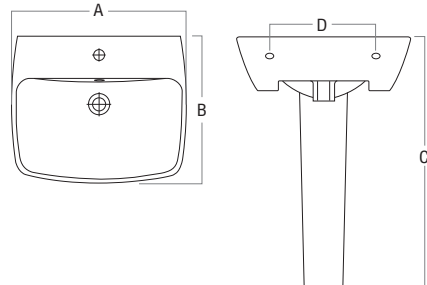

ITEM	A	B	C	D	Wgt. (kg)
40 cm WB	400	360	850	120	9.14
50 cm WB	500	420	850	200	11.7
55 cm WB	550	462	850	280	14.62
60cm WB	600	504	850	280	17.5

All dimensions are in mm. Tolerance ± 5%

Color range: **THAMES Series comes only in white color**

Thames BTW Conceal Flushing Water Closet ('P' Trap)

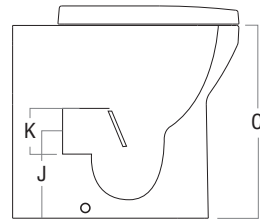
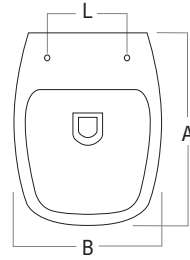

A	B	C	L	J	K	Wgt. (kg)
500	365	425	155	180	102	22.16

All dimensions are in mm. Tolerance ± 5%

Color range: **THAMES Series comes only in white color**

Moon Stone Table Top Wash Basin

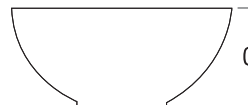
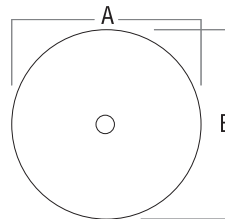

A	B	C	Wgt. (kg)
450	450	200	10

All dimensions are in mm. Tolerance ± 5%

Gracelia Single Piece 'S' Trap Water Closet

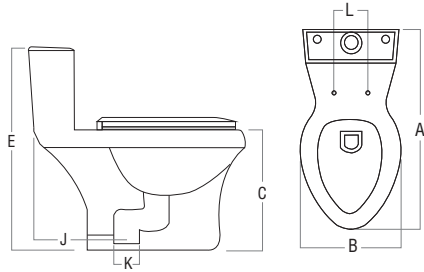

A	B	C	E	L	J	K	Wgt. (kg)
700	360	400	800	150	240	102	26.5

All dimensions are in mm. Tolerance ± 5%

Gracelia Wash Basin 50 cm

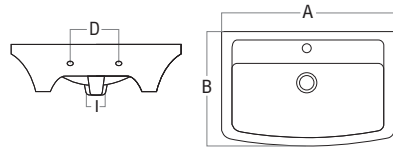

A	B	D	I	Wgt. (kg)
500	410	135	45	12

All dimensions are in mm. Tolerance ± 5%



Thames Wall Hung Conceal Flushing

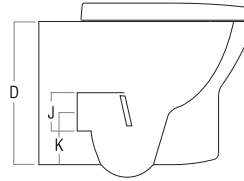
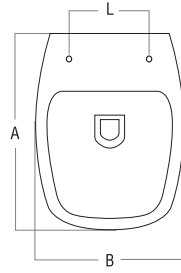

A	B	C	L	J	K	Wgt. (kg)
500	365	364	155	180	102	25.6

All dimensions are in mm. Tolerance $\pm 5\%$



Bonita 'P' Trap Wall Hung

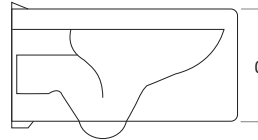
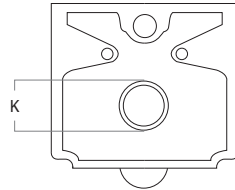
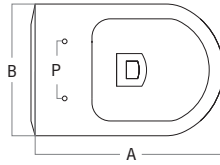

A	B	C	K	P	Wgt. (kg)
570	360	305	102	145	28

All dimensions are in mm. Tolerance $\pm 5\%$



Ritz - Wash Basin 50 cm

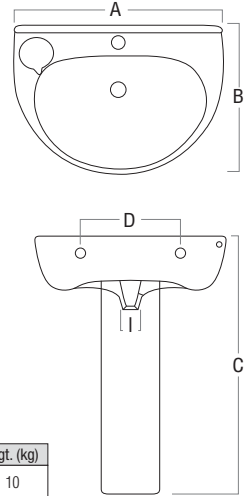

A	B	C	D	I	Wgt. (kg)
500	410	800	230	45	10

All dimensions are in mm. Tolerance $\pm 5\%$

Oriana - Wash Basin 50 cm

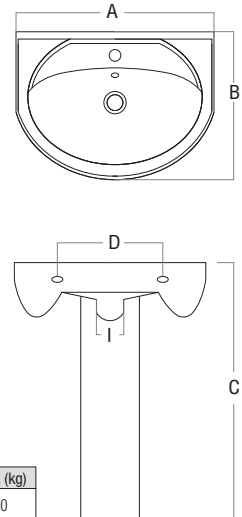

A	B	C	D	I	Wgt. (kg)
500	410	850	240	45	10

All dimensions are in mm. Tolerance $\pm 5\%$

Color range



Victoria - Wash Basin 55 cm

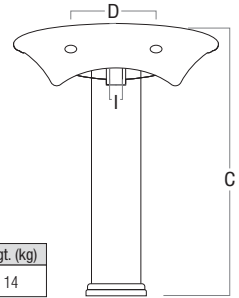
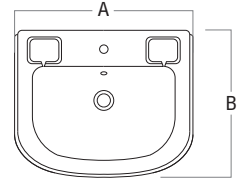

A	B	C	D	I	Wgt. (kg)
550	470	850	240	45	14

All dimensions are in mm. Tolerance $\pm 5\%$

Nova - Wash Basin 50 cm

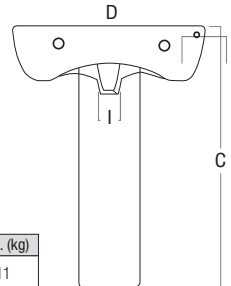
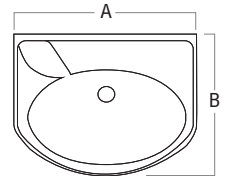

A	B	C	D	I	Wgt. (kg)
500	450	810	230	45	11

All dimensions are in mm. Tolerance $\pm 5\%$

Color range



ROSA

WASH BASIN

Margo - Wash Basin 50 cm

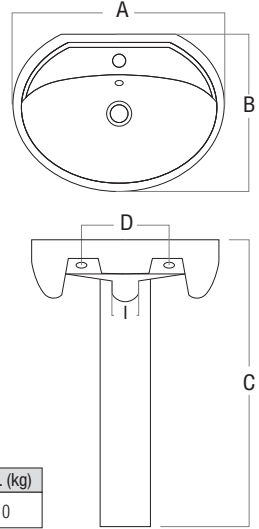

A	B	C	D	I	Wgt. (kg)
500	400	850	145	45	10

All dimensions are in mm. Tolerance $\pm 5\%$

Color range



Nathalia - Table Top

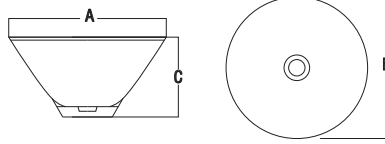

A	B	C	Wgt. (kg)
400	400	145	5.5

All dimensions are in mm. Tolerance $\pm 5\%$

Deigo - Over Counter

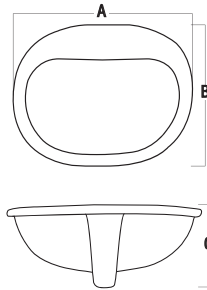

A	B	C	Wgt. (kg)
560	485	210	7

All dimensions are in mm. Tolerance $\pm 5\%$

Mona - Under Counter

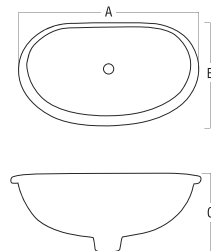

A	B	C	Wgt. (kg)
560	390	195	7

All dimensions are in mm. Tolerance $\pm 5\%$

Color range



Thames - Semi Counter Top Basin

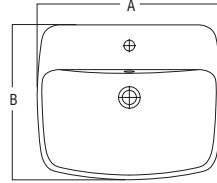

A	B	C	E	Wgt. (kg)
500	420	152	275	11.78

All dimensions are in mm. Tolerance $\pm 5\%$

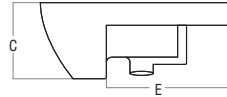

Quora - Table Top

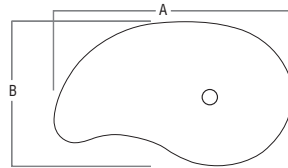

A	B	C	Wgt. (kg)
660	390	155	10

All dimensions are in mm. Tolerance $\pm 5\%$



Moon - Table Top



A	B	C	Wgt. (kg)
450	450	200	10

All dimensions are in mm. Tolerance $\pm 5\%$

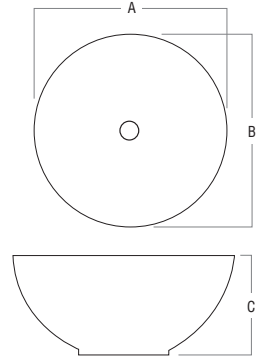

Shell Bowl - Table Top



A	B	C	Wgt. (kg)
435	345	185	7.5

All dimensions are in mm. Tolerance $\pm 5\%$

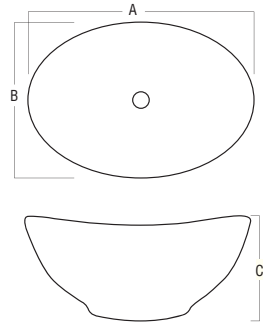

Thames - Short Projection Basin

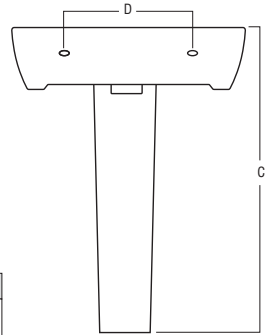
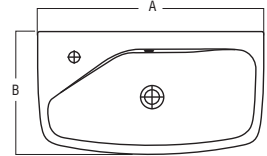

A	B	C	D	Wgt. (kg)
450	250	850	320	6.65

All dimensions are in mm. Tolerance $\pm 5\%$



ROSA

WASH BASIN

Corner Basin

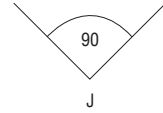
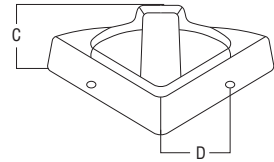
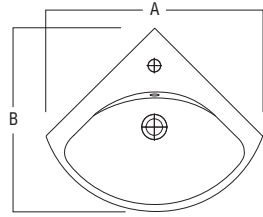

A	B	C	D	J	Wgt. (kg)
450	380	150	150	90°	6.28

All dimensions are in mm. Tolerance $\pm 5\%$



Lea 29 cm

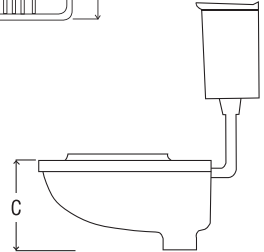
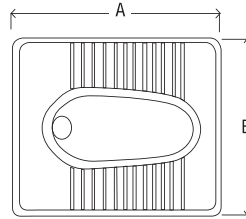

A	B	C	Wgt. (kg)
550	460	290	13

All dimensions are in mm. Tolerance $\pm 5\%$

Oriana 18 cm

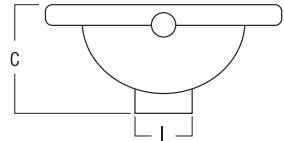
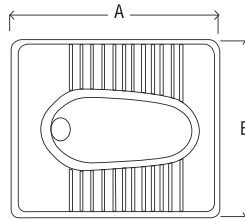

A	B	C	I	Wgt. (kg)
510	390	180	102	9

All dimensions are in mm. Tolerance $\pm 5\%$

Ritz 22 cm

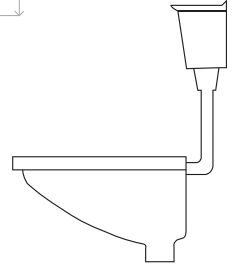
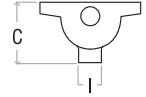
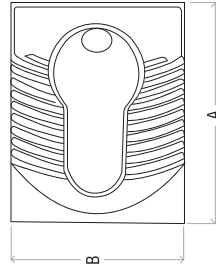

A	B	C	I	Wgt. (kg)
550	435	220	102	12

All dimensions are in mm. Tolerance $\pm 5\%$

Nova 22 cm

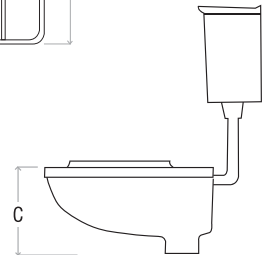
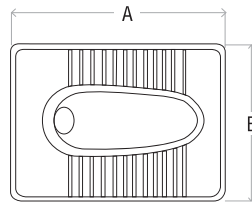

A	B	C	Wgt. (kg)
550	400	220	12

All dimensions are in mm. Tolerance $\pm 5\%$

COLOR CHART

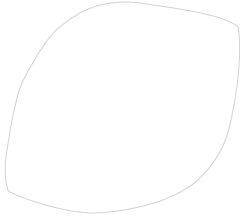

WHITE

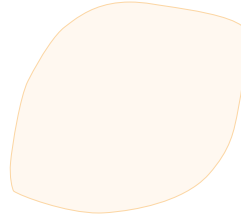

PURE IVORY



IVORY

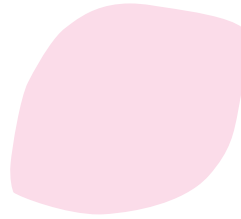

ROSE PINK



LIGHT BLUE



LIGHT GREEN

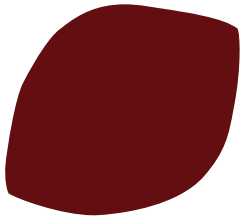

RUBY RED



LIGHT GREY

TECHNICAL SPECIFICATION

Dry pressed ceramic tiles with low water absorption Technical Specification

Date: 2020/02/05

ISO 13006:2012 (E), BDS ISO 13006:2006; Group B Ia (E ≤0.5%)

Work size: 300x300 mm / 400x400 mm / 600x600 mm / 600x1200 mm / 800x800 mm

Test Description	Test Method	International Standard	Bangladesh Standard	Akij Ceramics Value
Dimensional & surface quality				
Length & width, deviation in %	ISO 10545 2	±0.6%	±0.5%	±0.1%
Thickness, deviation in % of the average thickness		±5%	±5%	±4%
Straightness of sides, maximum deviation from straightness in %		±0.5%	±0.5%	±0.1%
Rectangularity, maximum deviation in %		±0.5%	±0.5%	±0.2%
Surface flatness, maximum deviation from the surface flatness in % a) centre curvature, related to diagonal, b) edge curvature, related to the work size, c) warpage, related to diagonal,		±0.5%	±0.5%	±0.2%
Surface quality		A minimum of 95% of the tiles shall be free from visible defects		Minimum of 98% free from visible
Physical properties				
Water absorption, % by weight	ISO 10545 3	≤0.5%	≤0.5%	≤0.2%
Modulus of rupture, in N/mm ²	ISO 10545 4	≥35	≥35	≥40
Resistance to deep abrasion of unglazed tiles: removed in volume, mm ³	ISO 10545 6	Maximum 175	Maximum 175	≤140
Resistance to surface abrasion: of glazed tiles intended for use on floor	ISO 10545 7	Report abrasion class & cycle passed	Report abrasion class & cycle passed	Min. Class II
Coefficient of linear thermal expansion, from ambient temperature to 100°C	ISO 10545 8	Test method available	Test method available	≤6x10 ⁻⁶
Thermal shock resistance	ISO 10545 9	Test method	Test method	Resistant
Crazing resistance, for glazed tiles	ISO 10545 11	Required	Required	3 Cycles Passes
Frost resistance	ISO 10545 12	Required	Required	Resistant
Chemical properties				
Resistance to staining a) glazed tiles; b) unglazed tiles;	ISO 10545 14	For glazed tile: Min. Class 3 For unglazed tile: Manufacturer to state classification	For glazed tile: Min. Class 3 For unglazed tile: Manufacturer to state classification	For glazed tile: Min. Class 3 For unglazed tile: Min. Class 2
Resistance to chemicals Resistance to low concentrations of acids and alkalis a) glazed tiles; b) unglazed tiles;	ISO 10545 13	Manufacturer to state classification	Manufacturer to state classification	No damage
Resistance to chemicals Resistance to high concentrations of acids and alkalis a) glazed tiles; b) unglazed tiles;	ISO 10545 13	Test method available	Test method available	No damage
Resistance to household chemicals and swimming pool salts a) glazed tiles; b) unglazed tiles	ISO 10545	Minimum GB Minimum UB	Minimum GB Minimum UB	Minimum GA Minimum UA

Product colors in this Brochure are as close to the actual product colors as possible through modern printing process. However, different light conditions and other technical aspects can cause variation in color or shapes. Please refer to actual product for colors.

Dry pressed ceramic tiles

Technical Specification

Date: 2019/10/19

ISO 13006:2012 (E), BDS ISO 13006:2006; Group B III (E>10%)

Work size: 300x500 mm / 300x600 mm / 200X600mm

Test Description	Test Method	International Standard ISO 13006:2012 (E)	Bangladesh Standard BDS ISO 13006 2006	Akij Ceramics Value		
Dimensional & surface quality						
Length & width, deviation in %	ISO 10545 2		±0.6% to 0.3%	±0.3%		
Thickness, deviation in % of the average thickness					±10%	±5%
Straightness of sites, maximum deviation from straightness in %					±0.3%	±0.3%
Rectangularity, maximum deviation in %					±0.5%	±0.3%
Surface flatness, maximum deviation from the surface flatness in % a) centre curvature, related to diagonal, b) edge curvature, related to the work size, c) warpage, related to diagonal,					+0.5% to 0.3%	+0.5% to 0.3%
Surface quality	A minimum of 95% of the tiles shall be free from visible defects		Minimum of 98% free from visible defects			
Physical properties						
Water absorption, % by weight	ISO 10545 3	Average >10%, Individual minimum 9%	Average >10%, Individual minimum 9%	10% to 15%		
Modulus of rupture, in N/mm ²	ISO 10545 4	≥15	≥15	≥16		
Thermal shock resistance	ISO 10545 9	Test method available	Test method available	Resistant		
Crazing resistance, for glazed tiles	ISO 10545 11	Required	Required	Resistant		
Frost resistance	ISO 10545 12	Required	Required	Resistant		
Chemical properties						
Resistance to staining a) glazed tiles;	ISO 10545 14	For glazed tile: Min. Class 3	For glazed tile: Min. Class 3	For glazed tile: Min. Class 4		
Resistance to chemicals Resistance to low concentrations of acids and alkalis a) glazed tiles;	ISO 10545 13	Test method available	Test method available	No damage		
Resistance to high concentrations of acids and alkalis (except HF) a) glazed tiles;	ISO 10545 13	Test method available	Test method available	No damage		

Corporate Office

Akij House, 198 Bir Uttam Mir Shawkat Sarak
(Gulshan Link Road), Tejgaon, Dhaka-1208, Bangladesh
For more: +880 1755621492-3

Exclusive Experience Centre

Dhaka

Mozaffar Tower, 55 Bir Uttam C.R. Dutta Road
(Old 41 Paribagh, Sonargaon Road), Banglamotor
Dhaka-1000, Bangladesh
Cell: +880 1777717583

3rd floor, **Navana Zohura Square**
22 Mymensingh Road, Banglamotor
Ramna, Dhaka. Mobile: +880 1713998704

Sylhet

1 Shahjalal Uposhohor, Block D
Mobile: +880 1777717586

Factory

Mukkhopur, Trishal, Mymensingh, Bangladesh



AKIJ CERAMICS
Promise of Perfection